

<b>Product Name:</b>	<b>Biofactory</b>
<b>Product Application:</b>	<p><b>Nest BioFactory™ Systems are compact, multi-layer, single-use cell culture systems designed for easy scale-up cell culture applications, can be used for medium to large scale research and industrial-scale production such as vaccines, monoclonal antibodies and biopharmaceuticals. It is suitable for adherent cell culture. Linear amplification will not change the kinetic conditions of cell growth.</b></p> <p><b>Specifications: single-layer, 2-layer, 5-layer, 10-layer, and 40-layer</b></p>
<b>Product Materials:</b>	<b>Polystyrene (PS), meets USP, Class VI.</b>
<b>product Specifications:</b>	<p>Temperature range: stored at room temperature</p> <p>Shelf life: 3 Years after date of production ( ensure package is in good )</p>
<b>Sterilization:</b>	<p><b>Yes.</b></p> <p>Sterilized by E-beam, Sterility Assurance Level: SAL=10<sup>-6</sup>. The product has been irradiated and dosimetrically released based on ANSI/AAMI/ISO 11137</p>
<b>Pyrogens:</b>	Non-Pyrogenic
<b>RNase/DNase:</b>	DNase/RNase free
<b>BSE/TSE:</b>	These products are deemed animal free.
<b>Performance Testing:</b>	<p>Each manufacturing lot is sampled and tested in accordance with standard operating procedures.</p> <p>Appearance inspection: qualified                      Particle Test: qualified</p> <p>Hydrophilic test: qualified                                      Cell culture test: qualified</p> <p>Packaging inspection: qualified</p>
<b>Features</b>	<ol style="list-style-type: none"> <li>Made of high clarity, Strictly selected polystyrene conforming to USP Class VI standard.</li> <li>Class 10,000 clean production workshop, process has been repeatedly verified, strict quality management, to ensure stable product quality.</li> <li>The irradiation sterilization process has passed ISO 13485 and ISO 11137 quality system certification.</li> <li>TC treated, good for adherent cell attachment and growth.</li> <li>Ultrasonic welding without extrinsic ingredients, without any chemical addition, eliminating the risk of unidentified leachables. Excellent welding line design can avoid producing particles during welding and increases the mechanical strength.</li> <li>Vent caps with 0.22um hydrophobic filters for gas exchange without contamination.</li> <li>Wide mouth is applicable to pour culture medium directly. Narrow mouth is applicable to operate with the aseptic pipeline.</li> <li>Growth kinetics are the same as cells grow in the cell culture flasks. Applicable to large-scale culture adherent cells.</li> </ol>

**Head Office** No. 530, Xida Road, Meicun Industrial Park, Xinwu District, Wuxi, Jiangsu, China  
 Tel: +86+ 510-6800 6788      Email: [info@nest-wuxi.com](mailto:info@nest-wuxi.com)  
 Online: [www.cell-nest.com](http://www.cell-nest.com)

**Oversea** NEST USA (New Jersey/ Phoenix)  
 NEST scientific 株式会社 (Yokohama, Japan)  
 NEST Scientific Europe B.V (Netherlands)  
 Nest Scientific (MENA) FZE (Sharjah, United Arab Emirates)

- 10. Large growing area. Just a single operate, you can cultivate a large number of cells and reduce contamination risk.
- 11. Biosafety testing Refer to <<State Food and Drug Administration National Standards for Packaging Materials and Containers in Direct Contact with Drugs (Series 6)>>
- 12. Applicable to automatic machine.
- 13. Standardize operations to reduce batch differences.
- 14. Double-layer sterile bag, clear lot number for batch traceability.

## Product Range

Cat.No.	Layer	Cap Style	Cultivation area (cm <sup>2</sup> )	/Case
771001	1	2 Wide Vent Caps (with 16 sterile wide plug seal caps included separately)	632	8
771101	2	2 Wide Vent Caps (with 16 sterile wide plug seal caps included separately)	1264	8
771204	5	2 Wide Vent Caps (with 8 sterile wide plug seal caps included separately)	3160	4
771302	10	2 Wide Vent Caps (with 12 sterile wide plug seal caps included separately)	6320	6
771403	40	2 Wide Vent Caps (with 4 sterile wide plug seal caps included separately)	25280	2
772001	1	2 Narrow Vent Caps (with 16 sterile narrow vent caps & 16 sterile narrow plug seal caps included separately)	632	8
772101	2	2 Narrow Vent Caps (with 16 sterile narrow vent caps & 16 sterile narrow plug seal caps included separately)	1264	8
772204	5	2 Narrow Vent Caps (with 4 sterile narrow vent caps & 4 sterile narrow plug seal caps included separately)	3160	4
772302	10	2 Narrow Vent Caps (with 8 sterile narrow vent caps & 8 sterile narrow plug seal caps included separately)	6320	6
772403	40	2 Narrow Vent Caps (with 4 sterile narrow vent caps & 4 sterile narrow plug seal caps included separately)	25280	2

**Head Office** No. 530, Xida Road, Meicun Industrial Park, Xinwu District, Wuxi, Jiangsu, China  
 Tel: +86+ 510-6800 6788 Email: [info@nest-wuxi.com](mailto:info@nest-wuxi.com)  
 Online: [www.cell-nest.com](http://www.cell-nest.com)

**Oversea** NEST USA (New Jersey/ Phoenix)  
 NEST scientific 株式会社 (Yokohama, Japan)  
 NEST Scientific Europe B.V (Netherlands)  
 Nest Scientific (MENA) FZE (Sharjah, United Arab Emirates)

773001	1	1 Wide Vent Cap & 1 Narrow Plug Seal Cap (with 16 sterile wide plug seal caps & 16 sterile narrow vent caps included separately)	632	8
773101	2	1 Wide Vent Cap & 1 Narrow Plug Seal Cap (with 16 sterile wide plug seal caps & 16 sterile narrow vent caps included separately)	1264	8
773204	5	1 Wide Vent Cap & 1 Narrow Plug Seal Cap (with 8 sterile wide plug seal caps & 8 sterile narrow vent caps included separately)	3160	4
773302	10	1 Wide Vent Cap & 1 Narrow Plug Seal Cap (with 12 sterile wide plug seal caps & 12 sterile narrow vent caps included separately)	6320	6
773403	40	1 Wide Vent Cap & 1 Narrow Plug Seal Cap (with 4 sterile wide plug seal caps & 4 sterile narrow vent caps included separately)	25280	2

## Technical Drawing

**Wide mouth:**

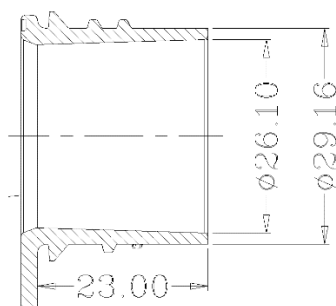

**Narrow mouth:**

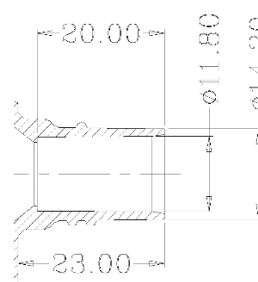

**Head Office** No. 530, Xida Road, Meicun Industrial Park, Xinwu District, Wuxi, Jiangsu, China  
 Tel: +86+ 510-6800 6788 Email: [info@nest-wuxi.com](mailto:info@nest-wuxi.com)  
 Online: [www.cell-nest.com](http://www.cell-nest.com)

**Oversea** NEST USA (New Jersey/ Phoenix)  
 NEST scientific 株式会社 (Yokohama, Japan)  
 NEST Scientific Europe B.V (Netherlands)  
 Nest Scientific (MENA) FZE (Sharjah, United Arab Emirates)

2 Wide Caps:

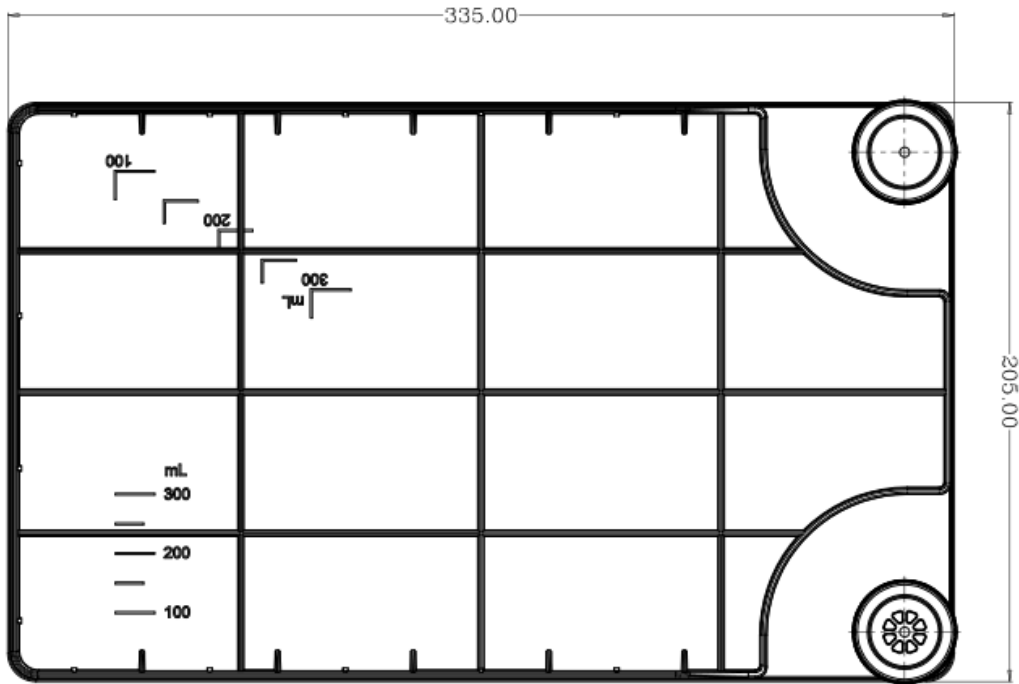

1 Layer

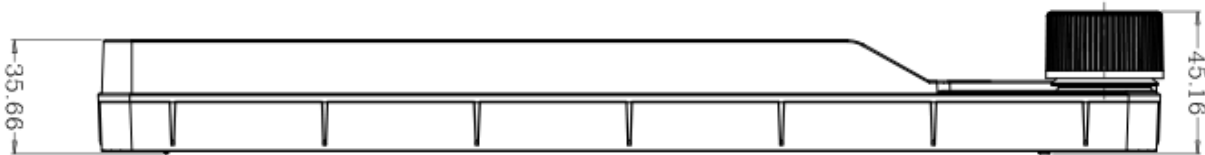

2 Layer

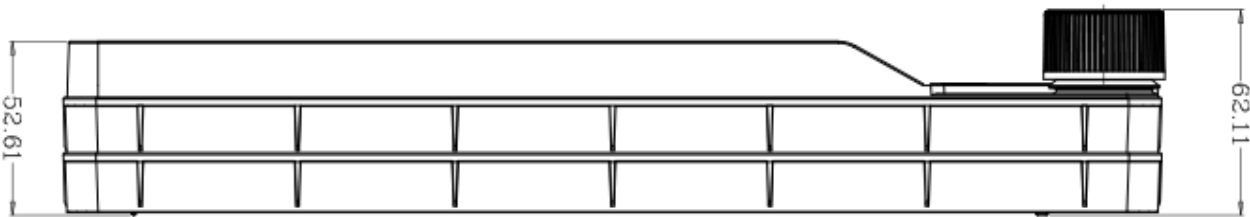

**Head Office** No. 530, Xida Road, Meicun Industrial Park, Xinwu District, Wuxi, Jiangsu, China  
 Tel: +86+ 510-6800 6788 Email: [info@nest-wuxi.com](mailto:info@nest-wuxi.com)  
 Online: [www.cell-nest.com](http://www.cell-nest.com)

**Oversea** NEST USA (New Jersey/ Phoenix)  
 NEST scientific 株式会社 (Yokohama, Japan)  
 NEST Scientific Europe B.V (Netherlands)  
 Nest Scientific (MENA) FZE (Sharjah, United Arab Emirates)

5 Layer

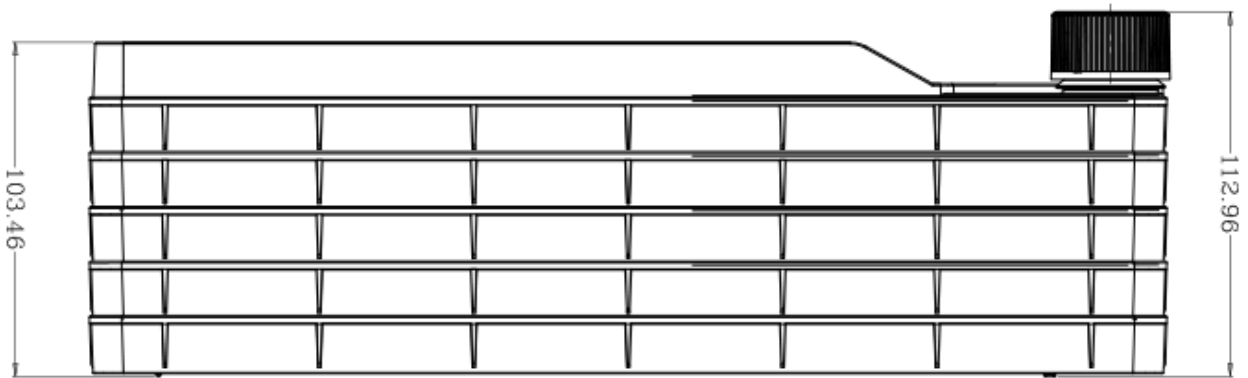

10 Layer

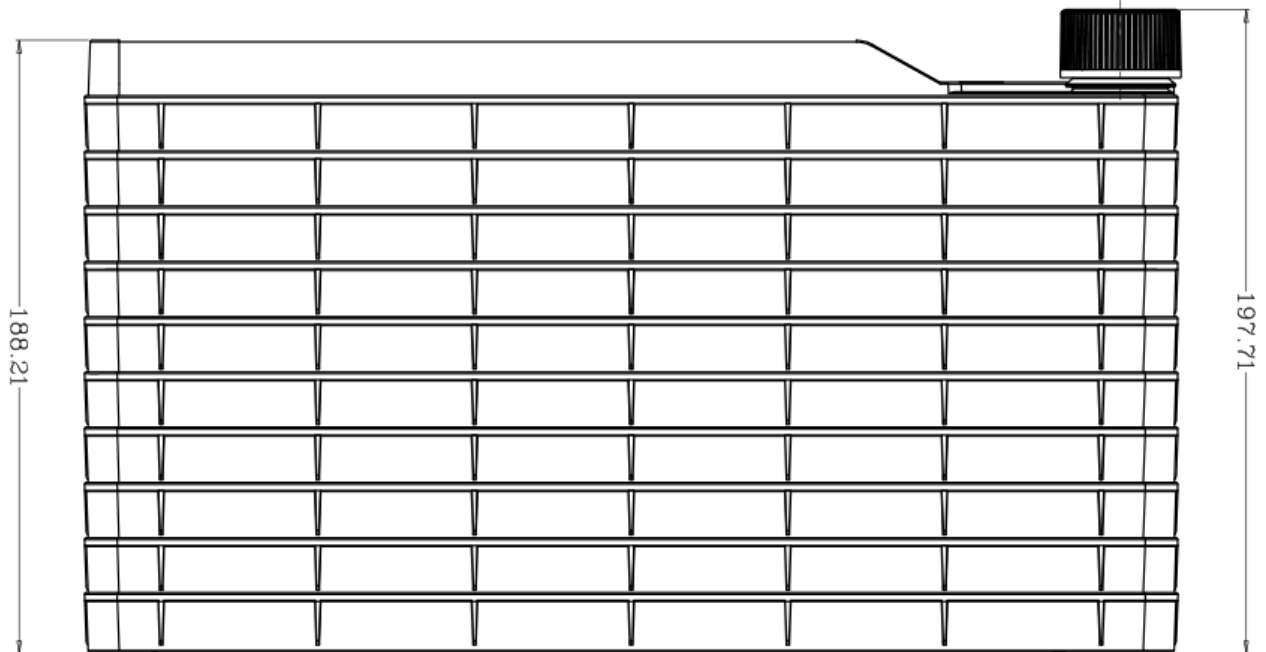

**Head Office** No. 530, Xida Road, Meicun Industrial Park, Xinwu District, Wuxi, Jiangsu, China  
Tel: +86+ 510-6800 6788 Email: [info@nest-wuxi.com](mailto:info@nest-wuxi.com)  
Online: [www.cell-nest.com](http://www.cell-nest.com)

**Oversea** NEST USA (New Jersey/ Phoenix)  
NEST scientific 株式会社 (Yokohama, Japan)  
NEST Scientific Europe B.V (Netherlands)  
Nest Scientific (MENA) FZE (Sharjah, United Arab Emirates)

40 Layer

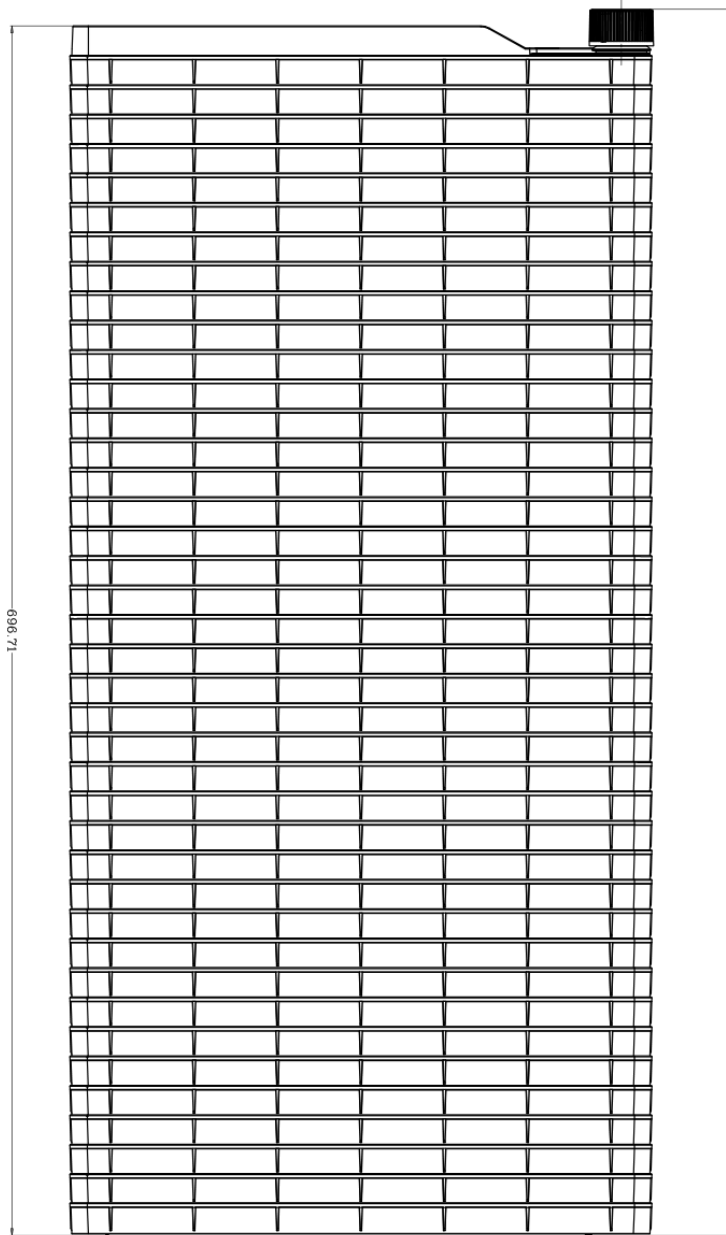

**Head Office** No. 530, Xida Road, Meicun Industrial Park, Xinwu District, Wuxi, Jiangsu, China  
Tel: +86+ 510-6800 6788 Email: [info@nest-wuxi.com](mailto:info@nest-wuxi.com)  
Online: [www.cell-nest.com](http://www.cell-nest.com)

**Oversea** NEST USA (New Jersey/ Phoenix)  
NEST scientific 株式会社 (Yokohama, Japan)  
NEST Scientific Europe B.V (Netherlands)  
Nest Scientific (MENA) FZE (Sharjah, United Arab Emirates)

2 Narrow Cap:

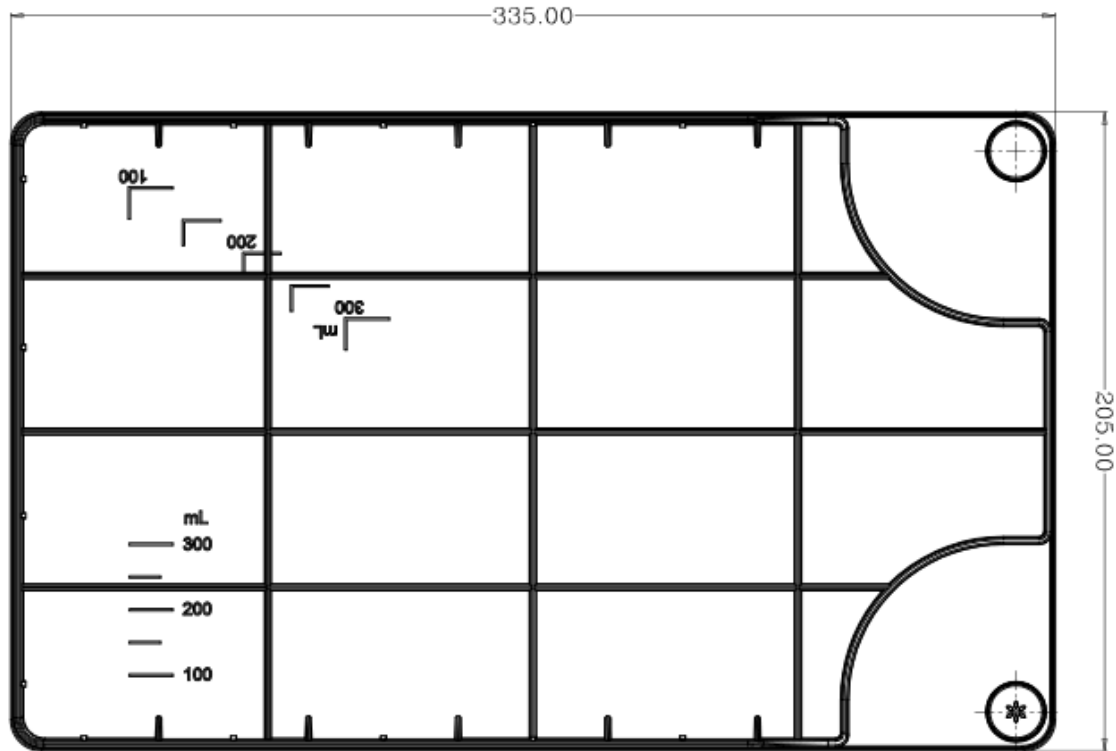

1 Layer

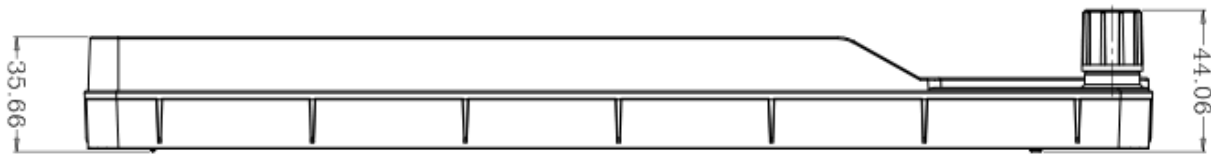

2 Layer

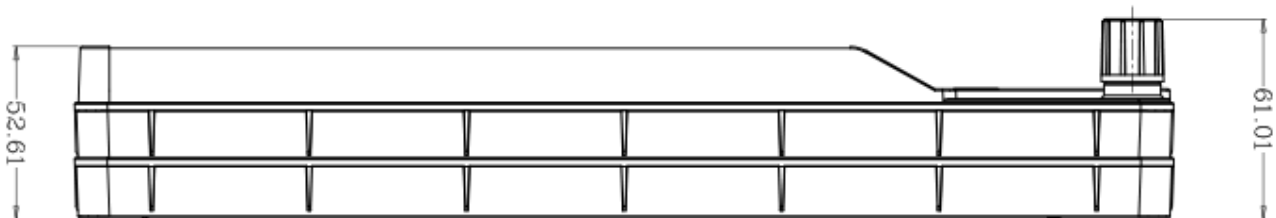

**Head Office** No. 530, Xida Road, Meicun Industrial Park, Xinwu District, Wuxi, Jiangsu, China  
 Tel: +86+ 510-6800 6788 Email: [info@nest-wuxi.com](mailto:info@nest-wuxi.com)  
 Online: [www.cell-nest.com](http://www.cell-nest.com)

**Oversea** NEST USA (New Jersey/ Phoenix)  
 NEST scientific 株式会社 (Yokohama, Japan)  
 NEST Scientific Europe B.V (Netherlands)  
 Nest Scientific (MENA) FZE (Sharjah, United Arab Emirates)

5 Layer

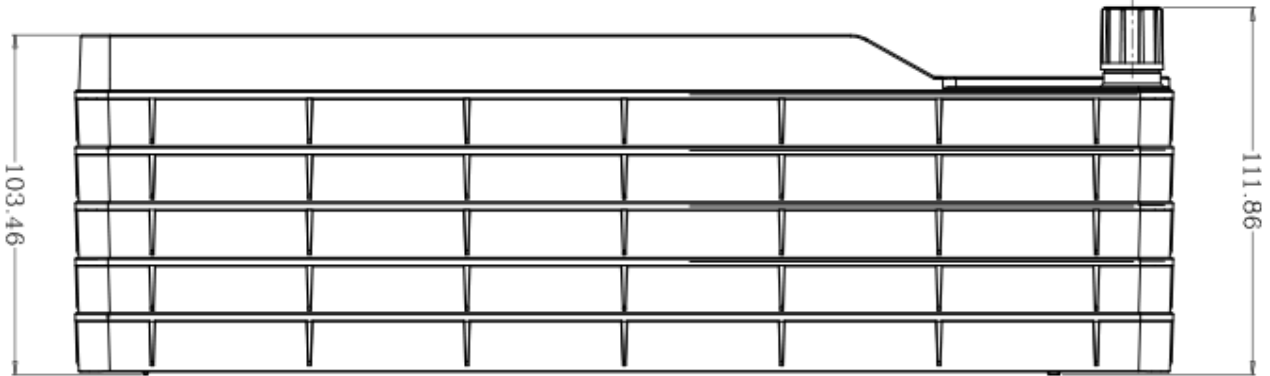

10 Layer

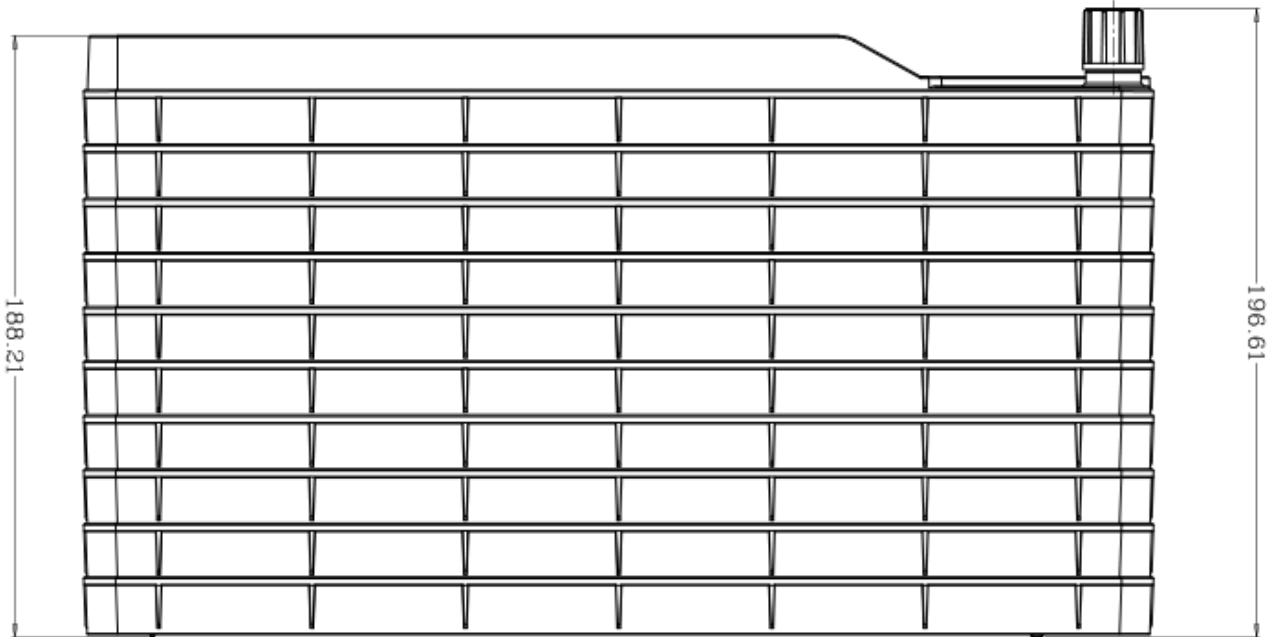

**Head Office** No. 530, Xida Road, Meicun Industrial Park, Xinwu District, Wuxi, Jiangsu, China  
Tel: +86+ 510-6800 6788 Email: [info@nest-wuxi.com](mailto:info@nest-wuxi.com)  
Online: [www.cell-nest.com](http://www.cell-nest.com)

**Oversea** NEST USA (New Jersey/ Phoenix)  
NEST scientific 株式会社 (Yokohama, Japan)  
NEST Scientific Europe B.V (Netherlands)  
Nest Scientific (MENA) FZE (Sharjah, United Arab Emirates)



40 Layer

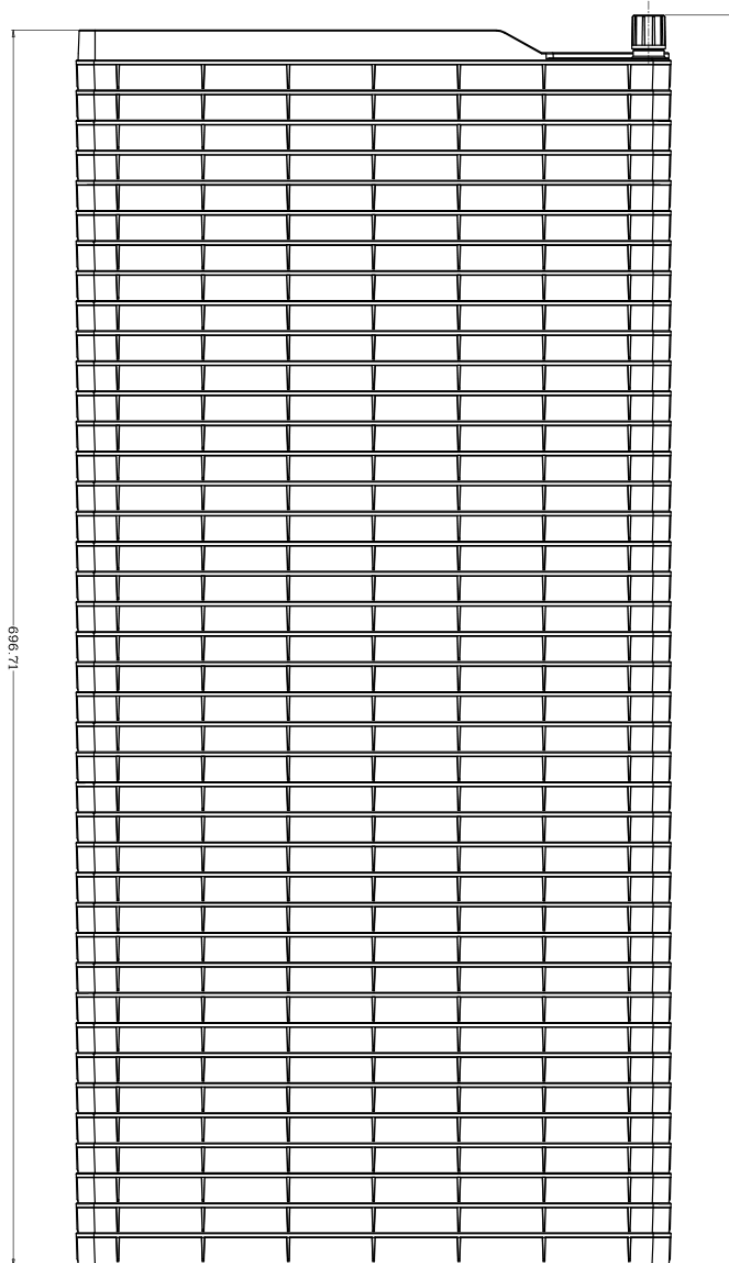

**Head Office** No. 530, Xida Road, Meicun Industrial Park, Xinwu District, Wuxi, Jiangsu, China  
Tel: +86+ 510-6800 6788 Email: [info@nest-wuxi.com](mailto:info@nest-wuxi.com)  
Online: [www.cell-nest.com](http://www.cell-nest.com)

**Oversea** NEST USA (New Jersey/ Phoenix)  
NEST scientific 株式会社 (Yokohama, Japan)  
NEST Scientific Europe B.V (Netherlands)  
Nest Scientific (MENA) FZE (Sharjah, United Arab Emirates)

1 Wide Cap & 1 Narrow Cap :

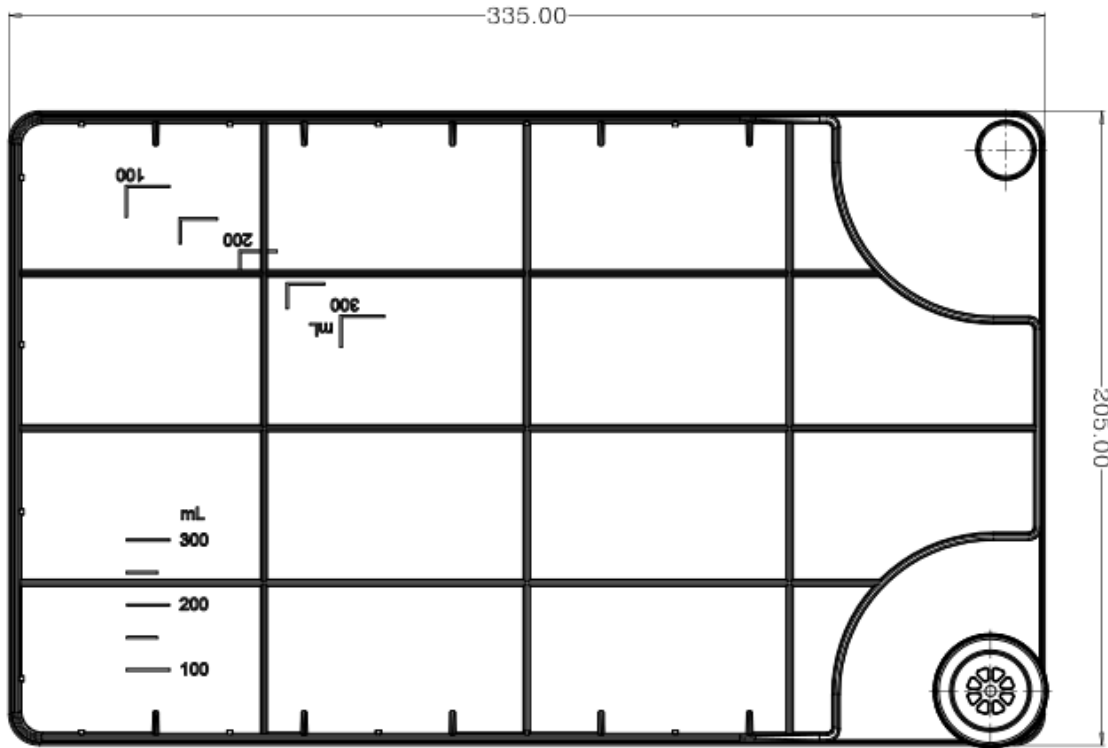

1 Layer



2 Layer

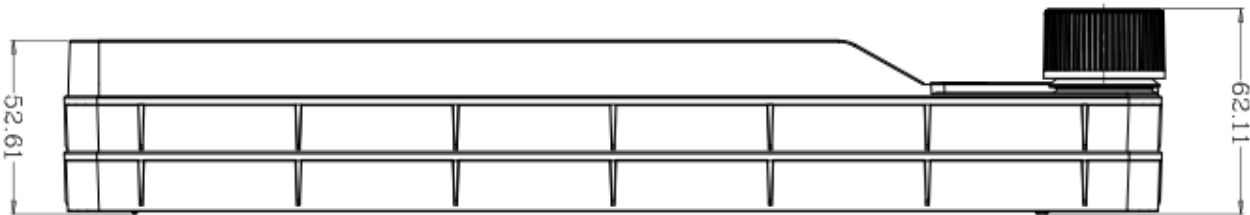

**Head Office** No. 530, Xida Road, Meicun Industrial Park, Xinwu District, Wuxi, Jiangsu, China  
 Tel: +86+ 510-6800 6788 Email: [info@nest-wuxi.com](mailto:info@nest-wuxi.com)  
 Online: [www.cell-nest.com](http://www.cell-nest.com)

**Oversea** NEST USA (New Jersey/ Phoenix)  
 NEST scientific 株式会社 (Yokohama, Japan)  
 NEST Scientific Europe B.V (Netherlands)  
 Nest Scientific (MENA) FZE (Sharjah, United Arab Emirates)

5 Layer

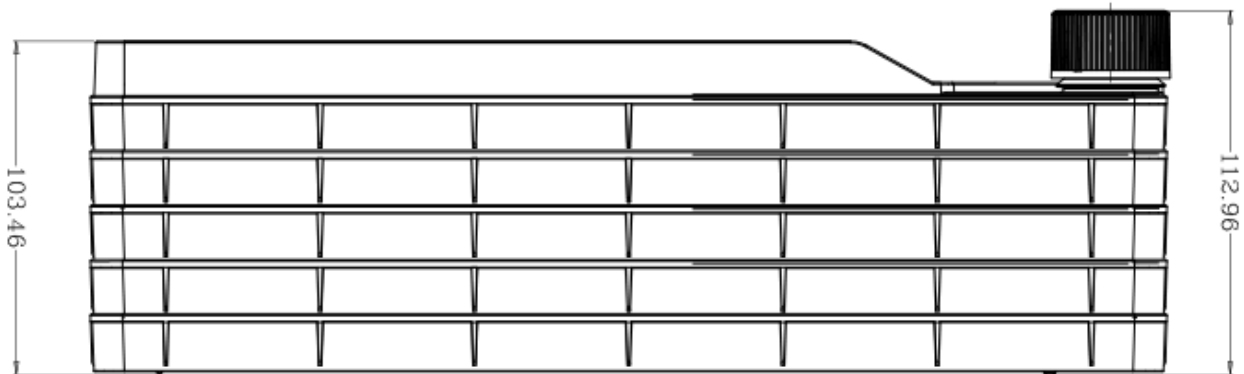

10 Layer

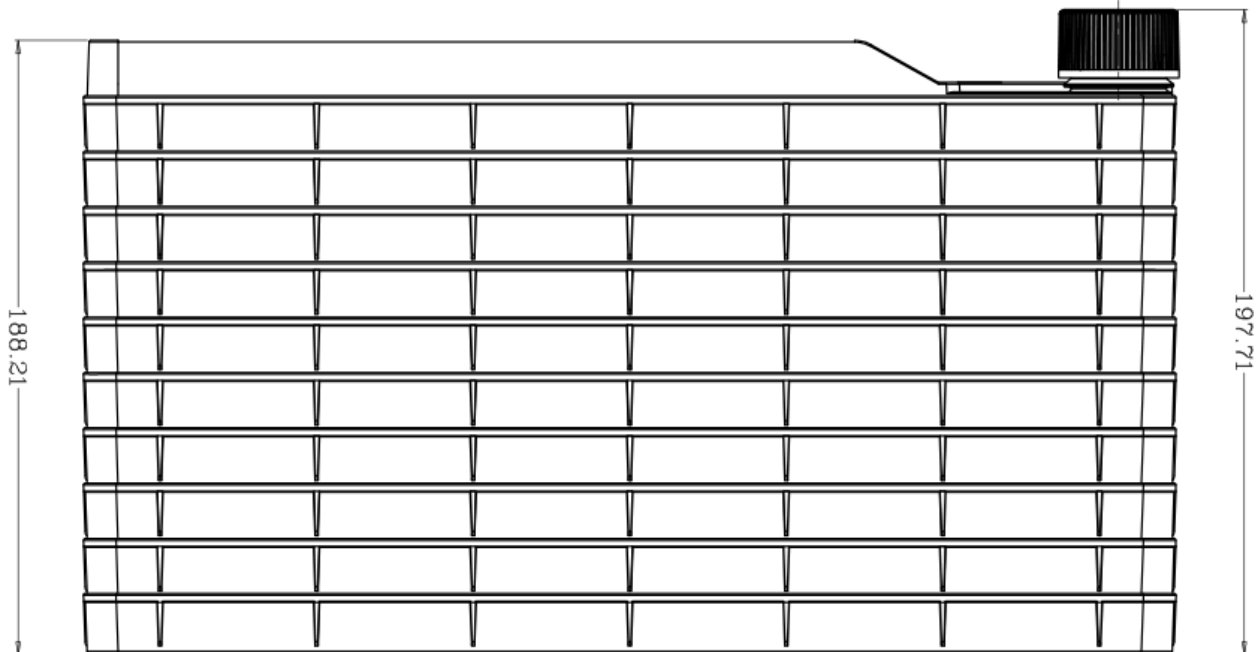

**Head Office** No. 530, Xida Road, Meicun Industrial Park, Xinwu District, Wuxi, Jiangsu, China  
Tel: +86+ 510-6800 6788 Email: [info@nest-wuxi.com](mailto:info@nest-wuxi.com)  
Online: [www.cell-nest.com](http://www.cell-nest.com)

**Oversea** NEST USA (New Jersey/ Phoenix)  
NEST scientific 株式会社 (Yokohama, Japan)  
NEST Scientific Europe B.V (Netherlands)  
Nest Scientific (MENA) FZE (Sharjah, United Arab Emirates)

40 Layer

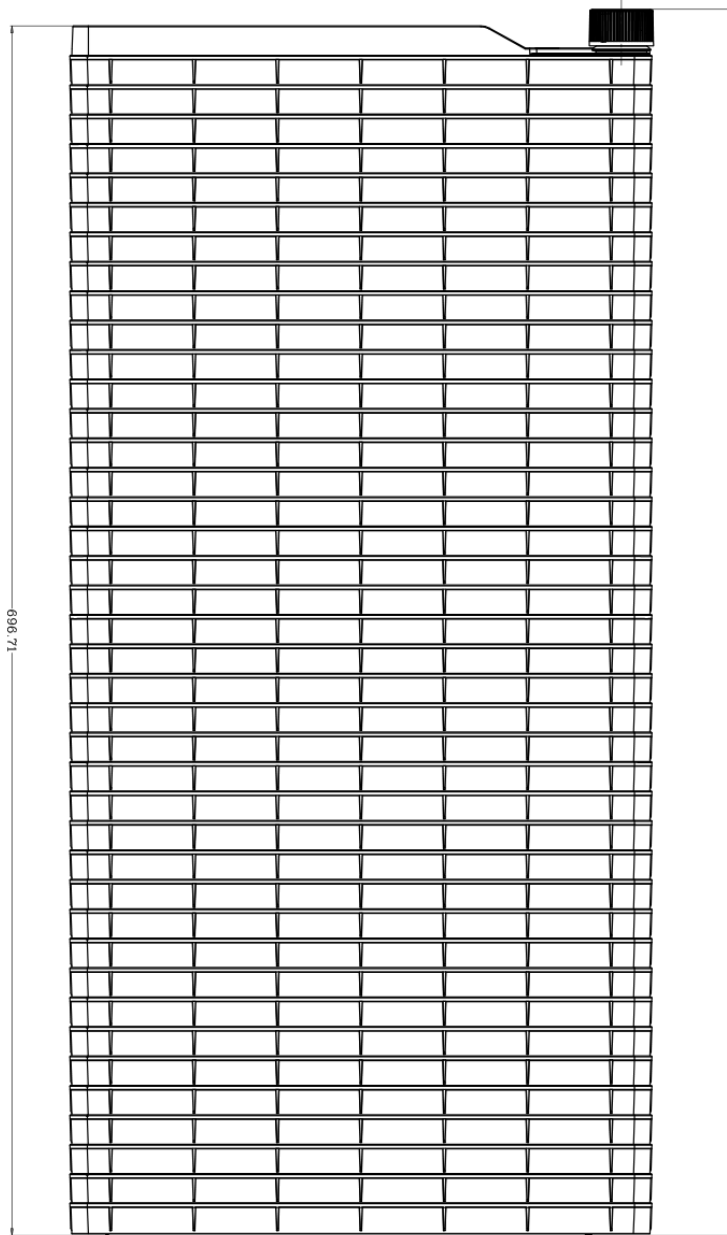

**Head Office** No. 530, Xida Road, Meicun Industrial Park, Xinwu District, Wuxi, Jiangsu, China  
Tel: +86+ 510-6800 6788 Email: [info@nest-wuxi.com](mailto:info@nest-wuxi.com)  
Online: [www.cell-nest.com](http://www.cell-nest.com)

**Oversea** NEST USA (New Jersey/ Phoenix)  
NEST scientific 株式会社 (Yokohama, Japan)  
NEST Scientific Europe B.V (Netherlands)  
Nest Scientific (MENA) FZE (Sharjah, United Arab Emirates)

Degree Scale

1 Layer

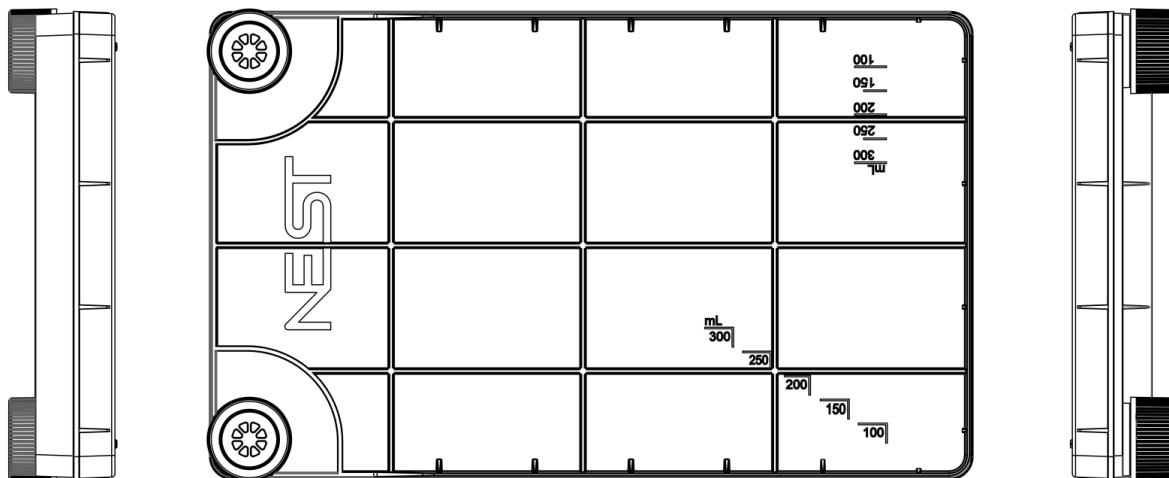

2 Layer

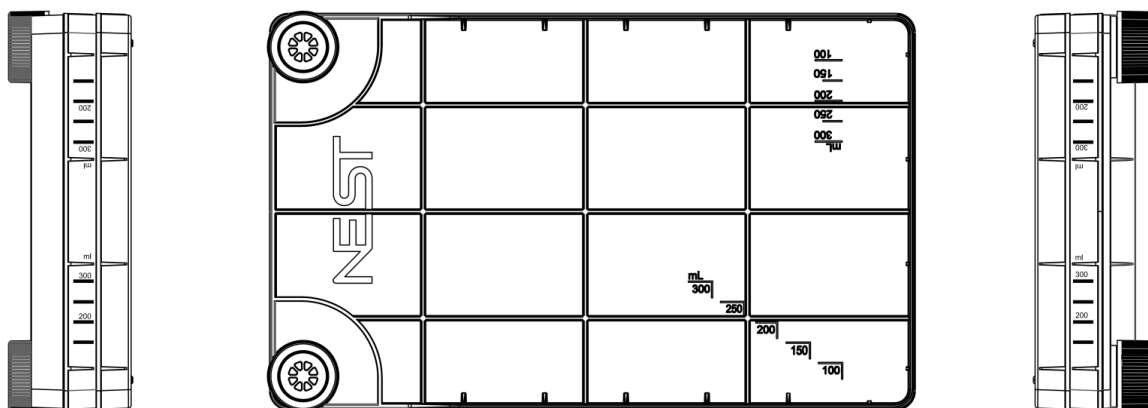

5 Layer

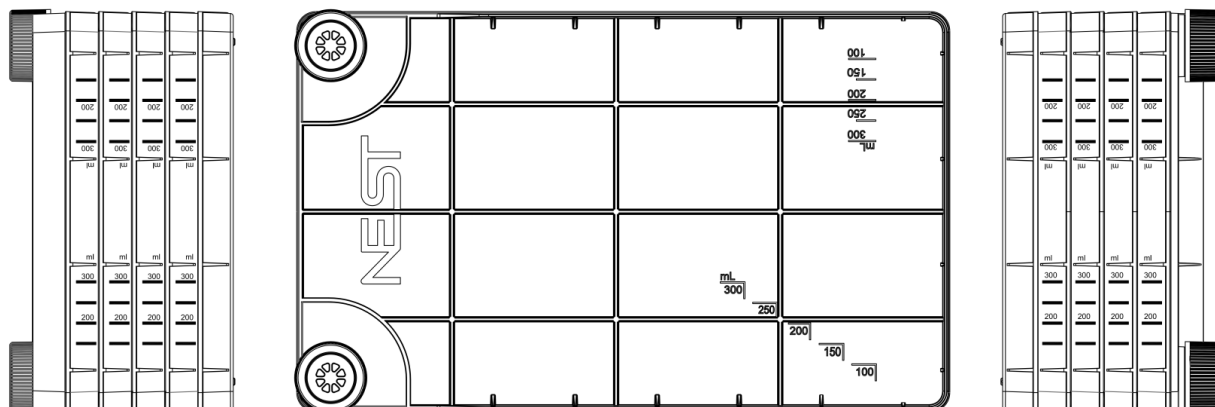

**Head Office** No. 530, Xida Road, Meicun Industrial Park, Xinwu District, Wuxi, Jiangsu, China  
 Tel: +86+ 510-6800 6788 Email: [info@nest-wuxi.com](mailto:info@nest-wuxi.com)  
 Online: [www.cell-nest.com](http://www.cell-nest.com)

**Oversea** NEST USA (New Jersey/ Phoenix)  
 NEST scientific 株式会社 (Yokohama, Japan)  
 NEST Scientific Europe B.V (Netherlands)  
 Nest Scientific (MENA) FZE (Sharjah, United Arab Emirates)

10 Layer

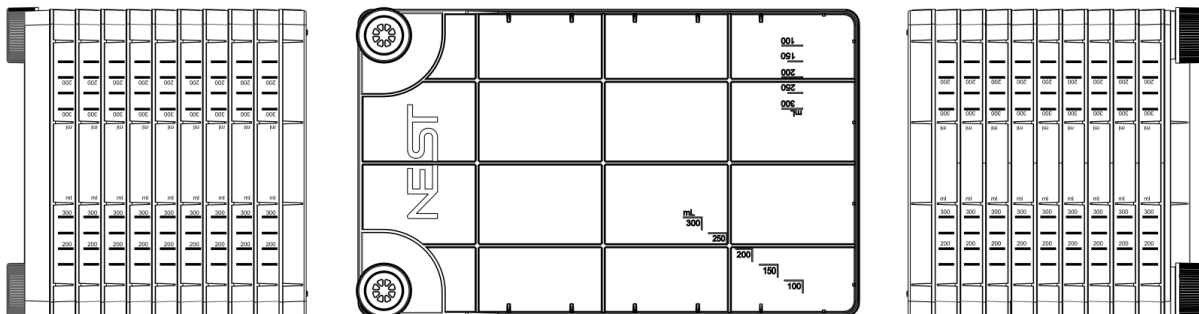

40 Layer

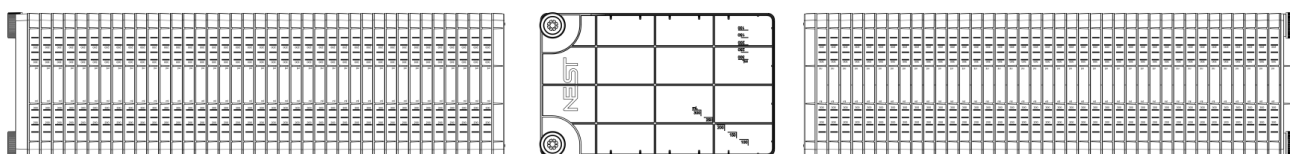

Wide Vent/ Plug Seal Caps

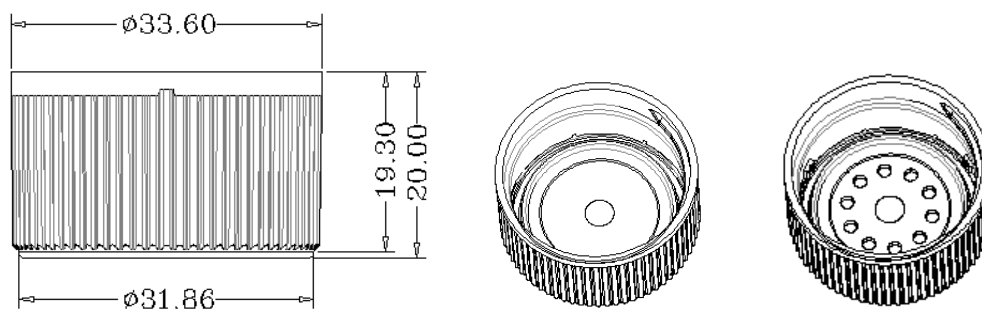

Narrow Vent/ Plug Seal Caps

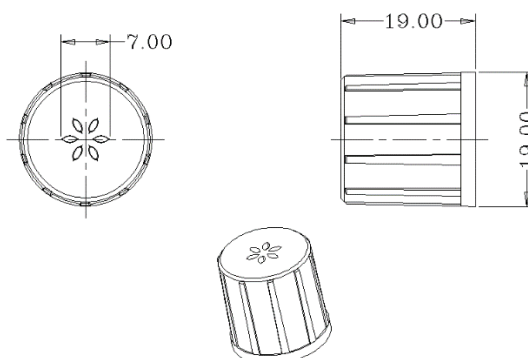

**Head Office** No. 530, Xida Road, Meicun Industrial Park, Xinwu District, Wuxi, Jiangsu, China  
 Tel: +86+ 510-6800 6788 Email: [info@nest-wuxi.com](mailto:info@nest-wuxi.com)  
 Online: [www.cell-nest.com](http://www.cell-nest.com)

**Oversea** NEST USA (New Jersey/ Phoenix)  
 NEST scientific 株式会社 (Yokohama, Japan)  
 NEST Scientific Europe B.V (Netherlands)  
 Nest Scientific (MENA) FZE (Sharjah, United Arab Emirates)